

为您的产品保驾护航

PRODUCT DATASHEET

Gas Discharge Tubes

JTA28H/JTN28H

Description

Gas discharge tubes (GDT) use noble gasses enclosed in ceramic tubes to provide an alternate circuit path for voltage spikes. The ceramic envelope and with nickel connectors allow for high loads and Ruilon offers products that function at 20KA, 40KA, 50KA, 60KA, 100KA & 150KA. The breakdown voltages of the devices have a wide range (up to 20% tolerance). Major applications are high frequency telecommunication lines, stations, security systems, HID and high quality Surge Protection Devices (SPD).

Features

- RoHS & HF compliant
- Size: 8.0mm*6.0mm
- DC Spark-over voltage: 75~800V
- Stable breakdown voltage.
- High insulation resistance.
- High holdover voltage.
- Large absorbing transient current capability.
- Low Capacitance
- Micro-Gap Design

Applications

- Cable Modem
- xDSL
- Set-Top Box
- Satellite and CATV equipment
- Power supplier
- Consumer electronics
- General telecom equipment

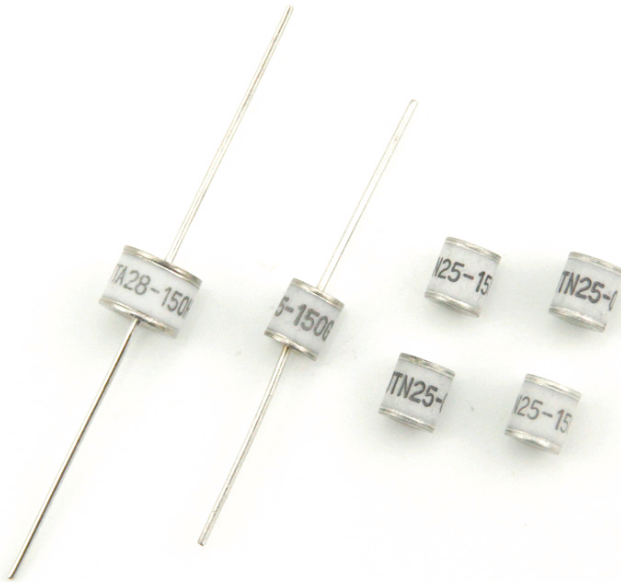

Product Identification

JT A 2 8 -075 H

H = Surge Rating

Blank=0.5kA, B=2kA, D=3kA,
G=5kA, H=10kA, K=20kA,
M=40kA, P=60kA

075 = DC Spark-over Voltage 75V

8 = 8mm Diameter

2 = 2 Electrode Device

A = Lead Configuration

A=Axial Leads
N=No Leads
S=Surface Mount
T=T-shaped Leads

JT = JDT Gas Discharge Tube

Performance Specification

Part Number	DC Spark-over Voltage	Maximum Impulse Breakdown Voltage		Max. Impulse Discharge Current (8/20 μ s)		Impulse Life (10/1000 μ s)	Normal Alternating Discharge Current		DC Holdover Voltage	Minimum Insulation Resistance	Maximum Capacitance (1MHz)	
		1kV/ μ S	1KV/ μ S	1 times	10 times		100 A	50Hz 1Sec				Single 9 Cycles
		(V)	(V)	(KA)				(A)				(V)
JTA28-070H	70 \pm 20%	500	600	15	10	300	10	65	52	1	1.5	
JTA28-075H	75 \pm 20%	500	600	15	10	300	10	65	52	1	1.5	
JTA28-090H	90 \pm 20%	500	600	15	10	300	10	65	52	1	1.5	
JTA28-120H	120 \pm 20%	500	700	15	10	300	10	65	52	1	1.5	
JTA28-130H	130 \pm 20%	500	700	15	10	300	10	65	52	1	1.5	
JTA28-150H	150 \pm 20%	500	700	15	10	300	10	65	52	1	1.5	
JTA28-230H	230 \pm 20%	500	700	15	10	300	10	65	80	1	1.5	
JTA28-250H	250 \pm 20%	500	700	15	10	300	10	65	135	1	1.5	
JTA28-300H	300 \pm 20%	700	900	15	10	300	10	65	150	1	1.5	
JTA28-350H	350 \pm 20%	700	900	15	10	300	10	65	150	1	1.5	
JTA28-400H	400 \pm 20%	800	1000	15	10	300	10	65	150	1	1.5	
JTA28-470H	470 \pm 20%	900	1100	15	10	300	10	65	150	1	1.5	
JTA28-600H	600 \pm 20%	1100	1300	15	10	300	10	65	150	1	1.5	
JTA28-800H	800 \pm 20%	1300	1500	15	10	300	10	65	150	1	1.5	
JTN28-070H	70 \pm 20%	500	600	15	10	300	10	65	52	1	1.5	
JTN28-075H	75 \pm 20%	500	600	15	10	300	10	65	52	1	1.5	
JTN28-090H	90 \pm 20%	500	600	15	10	300	10	65	52	1	1.5	
JTN28-120H	120 \pm 20%	500	700	15	10	300	10	65	52	1	1.5	
JTN28-130H	130 \pm 20%	500	700	15	10	300	10	65	52	1	1.5	
JTN28-150H	150 \pm 20%	500	700	15	10	300	10	65	52	1	1.5	
JTN28-230H	230 \pm 20%	500	700	15	10	300	10	65	80	1	1.5	
JTN28-250H	250 \pm 20%	500	700	15	10	300	10	65	135	1	1.5	
JTN28-300H	300 \pm 20%	700	900	15	10	300	10	65	150	1	1.5	
JTN28-350H	350 \pm 20%	700	900	15	10	300	10	65	150	1	1.5	
JTN28-400H	400 \pm 20%	800	1000	15	10	300	10	65	150	1	1.5	
JTN28-470H	470 \pm 20%	900	1100	15	10	300	10	65	150	1	1.5	
JTN28-600H	600 \pm 20%	1100	1300	15	10	300	10	65	150	1	1.5	
JTN28-800H	800 \pm 20%	1300	1500	15	10	300	10	65	150	1	1.5	

DC Spark-over Voltage	DC Measuring Voltage
70-90V	50V
120-400V	100V
470-800V	250V

Soldering Parameters

Reflow Condition Pb-Free Assembly

Preheat

-Temperature Min($T_{s\ min}$)	150°C
-Temperature Max($T_{s\ max}$)	200°C
-Time($T_{s\ min}$ to $T_{s\ max}$)	60~180 seconds

Average Ramp-Up Rate (Liquidus Temp(T_L) to peak)	3°C/second max
---	----------------

$T_{s(max)}$ to T_L - Ramp-up Rate	5°C/second max
--------------------------------------	----------------

Reflow:

- Temperature (T_L) (Liquidus)	217°C
- Time (min to max) (t_s)	60~150 seconds

Peak Temperature(T_p)	260 ^{+0/-5} °C
---------------------------	-------------------------

Time within 5°C of actual peak Temperature (t_p)	10~30 seconds
--	---------------

Ramp-Down Rate	6°C/second max
----------------	----------------

Time 25°C to Peak Temperature	8 minutes max
-------------------------------	---------------

Do not exceed	260°C
---------------	-------

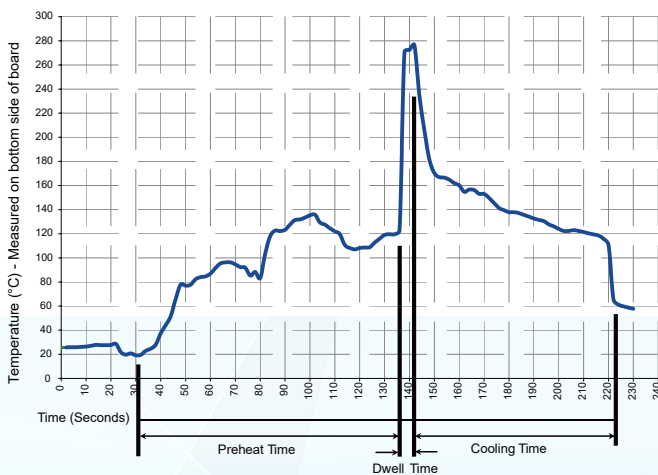
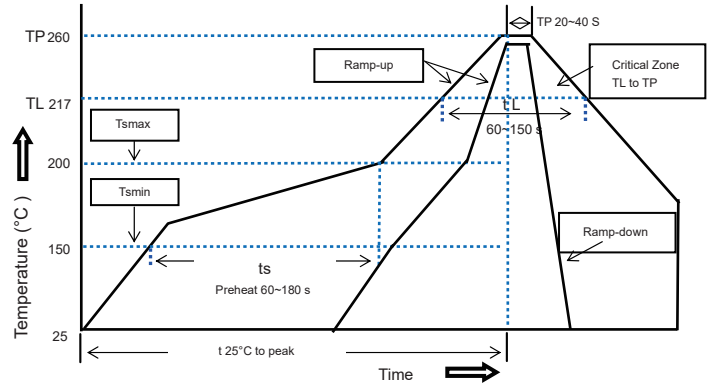

Soldering Parameters

Recommended Process Parameters:

Wave Parameter	Lead-Free Recommendation
----------------	--------------------------

Preheat:

(Depends on Flux Activation Temperature) (Typical Industry Recommendation)

Temperature Minimum:	100° C
----------------------	--------

Temperature Maximum:	150° C
----------------------	--------

Preheat Time:	60-180 seconds
---------------	----------------

Solder Pot Temperature:	260° C Maximum
-------------------------	----------------

Solder Dwell Time:	2-5 seconds
--------------------	-------------

Dimension unit:(mm)

DIP Series (2RxxxxT-8)

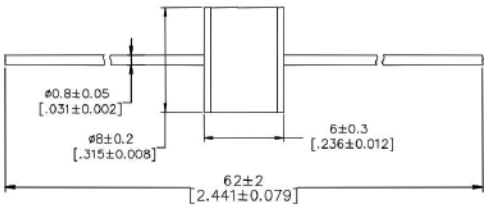

SMD Series (2RxxxxS-8)

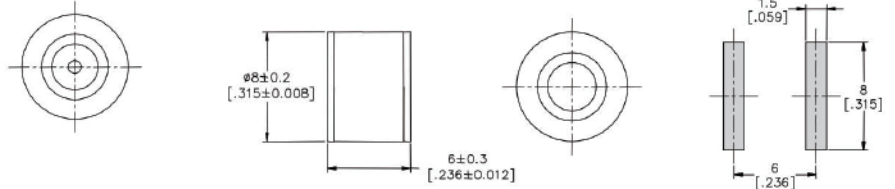

Recommended Soldering Pad Layout

Packaging Taping

For " T " Type Axial Lead Items

Plastic Tray
(252×135×10mm)

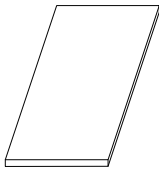

100 PCS/ Plastic Tray

Inner Box
(270×145×50mm)

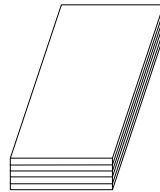

500 PCS/ Box

Outside Box
(310×280×275mm)

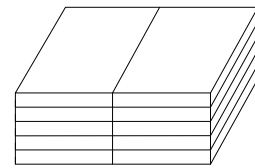

5,000 PCS/ Carton

Core and ' S ' Type Items

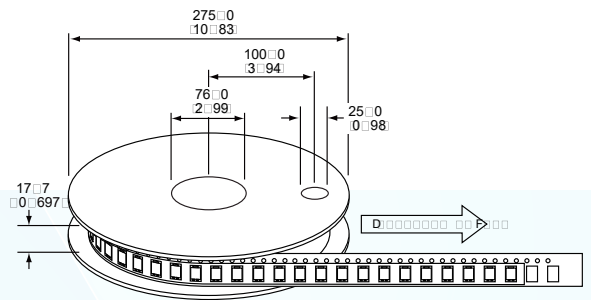
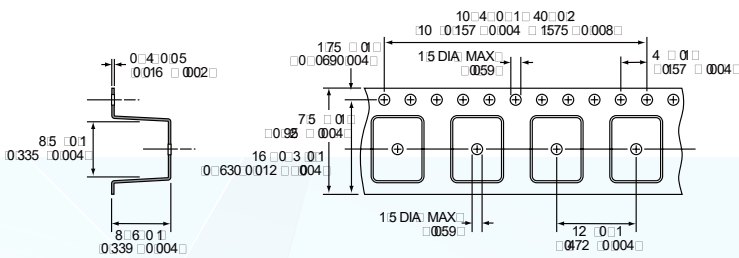

Warehouse Storage Conditions of Products

· Storage Conditions:

1. Storage Temperature: -10°C~+40°C
2. Relative Humidity: ≤75%RH
3. Keep away from corrosive atmosphere and sunlight.

· Period of Storage: 1 year