



为您的产品保驾护航

PRODUCT DATASHEET

Electro-Static Discharge

JEN1610-5V-ULC ESD

Features

- Small package: 1.6x1.0x0.5mm(DFN1610)
- Ultra low capacitance: 0.3 pF typical
- Ultra low leakage: nA level
- Operating Voltage: 5V
- Low clamping voltage
- 2-pin leadless package
- Complies with following standards:
 - IEC 61000-4-2 (ESD) immunity test
Air discharge: $\pm 25\text{kV}$
Contact discharge: $\pm 22\text{kV}$
 - IEC61000-4-5 (Lightning) 4A (8/20 μs)
- RoHS compliant

Applications

- Cellular Handsets and Accessories
- Display Ports
- MDDI Ports
- USB Ports
- Digital Visual Interface (DVI)
- PCI Express and Serial SATA Ports

Schematic Diagram

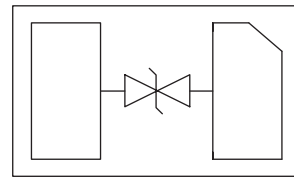

Pin Description

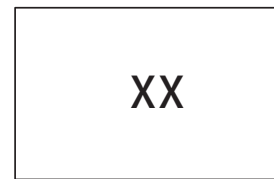

Limiting Values($T_A = 25\text{ }^\circ\text{C}$, unless otherwise specified)

Symbol	Parameter	Conditions	Value	Unit
V _{ESD}	Electrostatic Discharge Voltage	IEC 61000-4-2;Contact Discharge	± 22	kV
		IEC 61000-4-2;Air Discharge	± 25	kV
PPP	Peak Pulse Power	$t_P=8/20\mu\text{s}$	100	W
I _{PP}	Peak Pulse Current	$t_P=8/20\mu\text{s}$	4	A
T _J	Operating Temperature Range	-	-55 to +125	$^\circ\text{C}$
T _{stg}	Storage Temperature Range	-	-55 to +150	$^\circ\text{C}$

Electrical Characteristics($T_A = 25\text{ }^\circ\text{C}$, unless otherwise specified)

Symbol	Parameter	Conditions	Min	Typ.	Max	Unit
V _{RWM}	Reverse Working Voltage	$T_A=25\text{ }^\circ\text{C}$	-	-	5	V
V _{BR}	Breakdown Voltage	$I_T=1\text{mA}$	6.5	-	9.5	V
I _R	Reverse Leakage Current	V _{RWM} =5V	-	-	0.2	μA
V _C	Clamping Voltage	I _{PP} =1A(8x20 μs pulse)	-	-	12	V
V _C	Clamping Voltage	I _{PP} =4A(8x20 μs pulse)	-	-	20	V
C _J	Junction Capacitance	V _R =0V,f=1 MHz	-	0.3	0.5	pF

Typical Characteristics

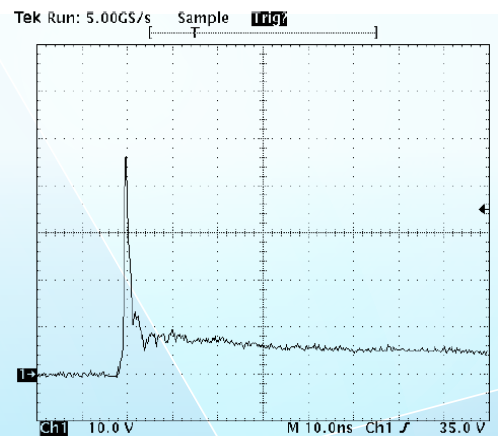
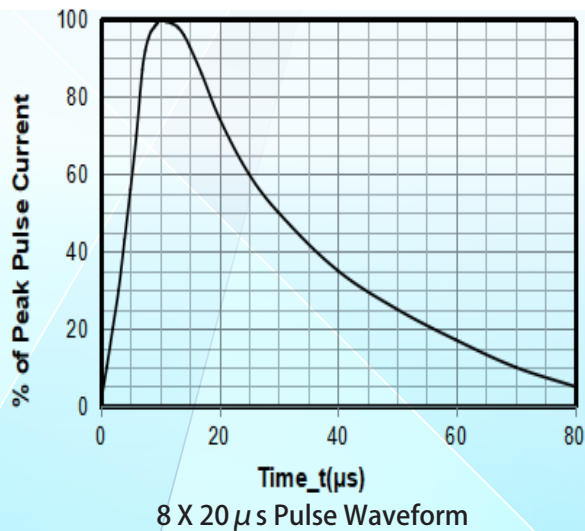
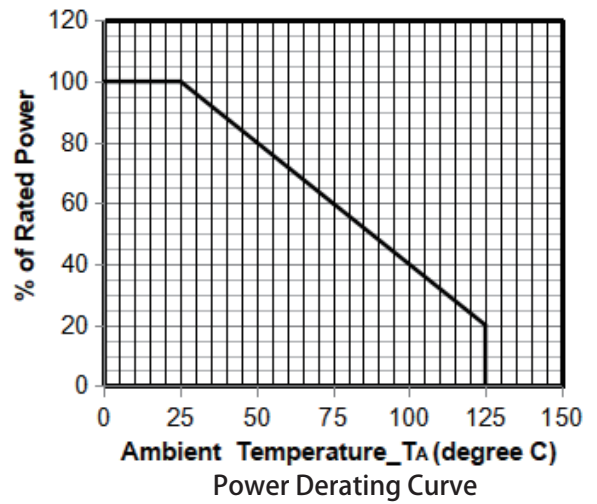
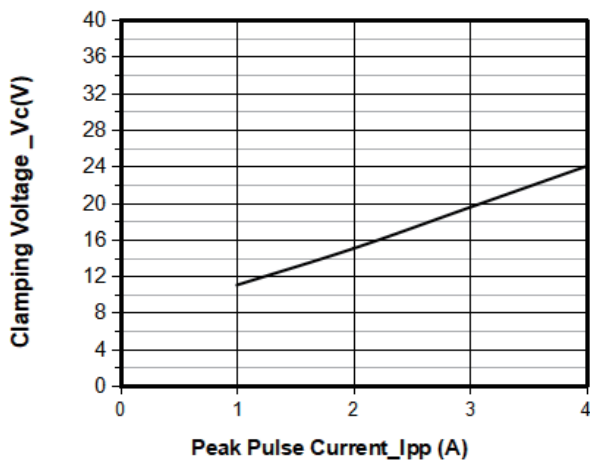
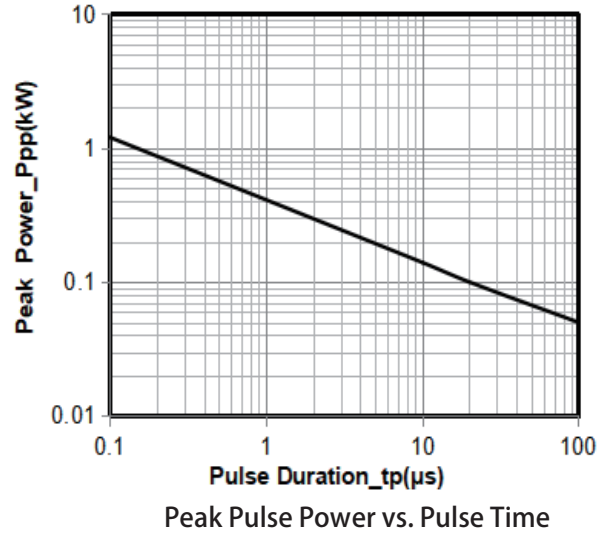
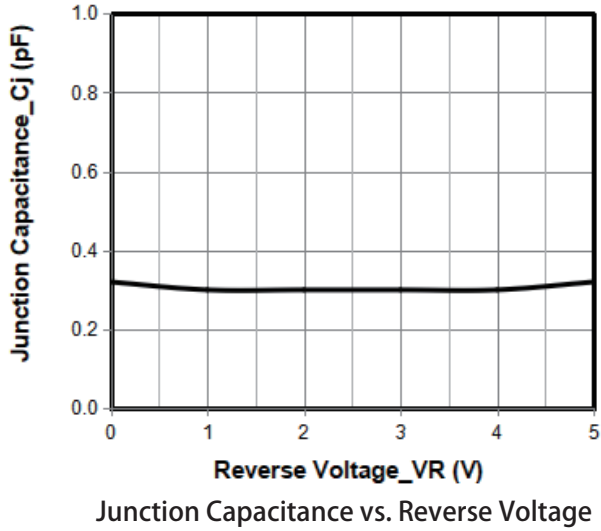

Note: Data is taken with a 10x attenuator
ESD Clamping Voltage
8 kV Contact per IEC61000-4-2

Physical Dimensions(mm.)

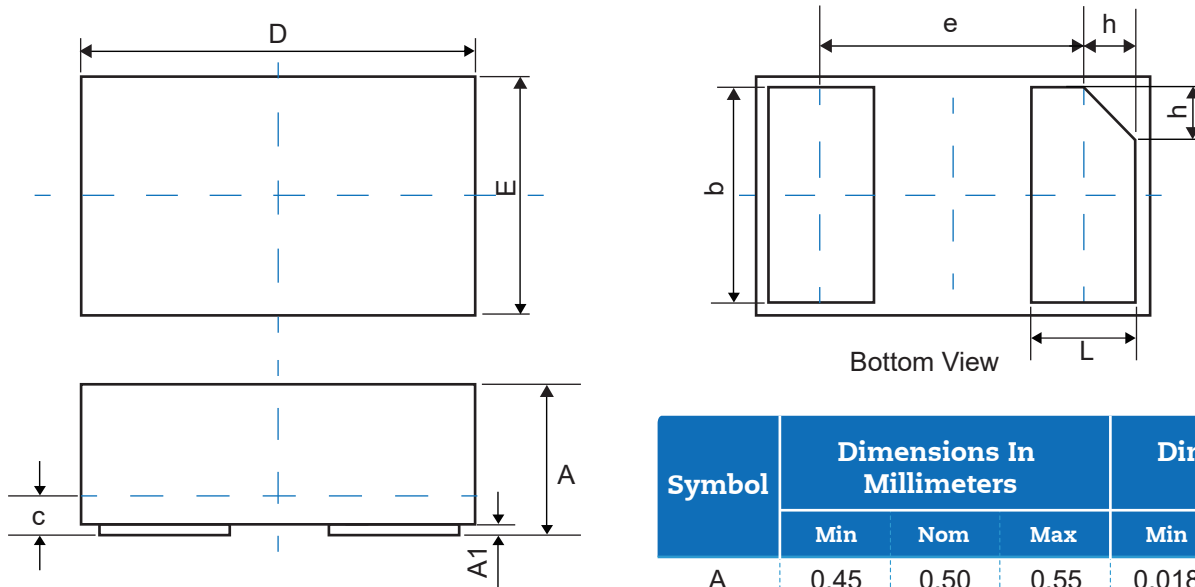

Symbol	Dimensions In Millimeters			Dimensions In Inches		
	Min	Nom	Max	Min	Nom	Max
A	0.45	0.50	0.55	0.018	0.020	0.022
A1	0.00	0.02	0.05	0.000	0.001	0.002
b	0.75	0.80	0.85	0.030	0.032	0.034
c	0.10	0.15	0.20	0.004	0.006	0.008
D	1.55	1.60	1.65	0.062	0.064	0.066
e	1.10 BSC			0.044 BSC		
E	0.95	1.00	1.05	0.038	0.040	0.042
L	0.35	0.40	0.45	0.014	0.016	0.018
h	0.15	0.20	0.25	0.006	0.008	0.010

Suggested Land Pattern

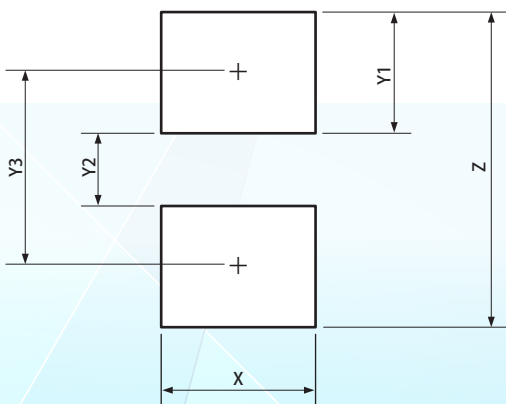

Symbol	Dimensions	
	Millimeters	Inches
X	1.00	0.040
Y1	0.62	0.025
Y2	0.60	0.024
Y3	1.22	0.049
Z	1.85	0.074

Packaging Quantity

Part Number	Delivery Form	Delivery Quantity
JEN1610-5V-ULC	7"T&R	3,000

Soldering Parameters

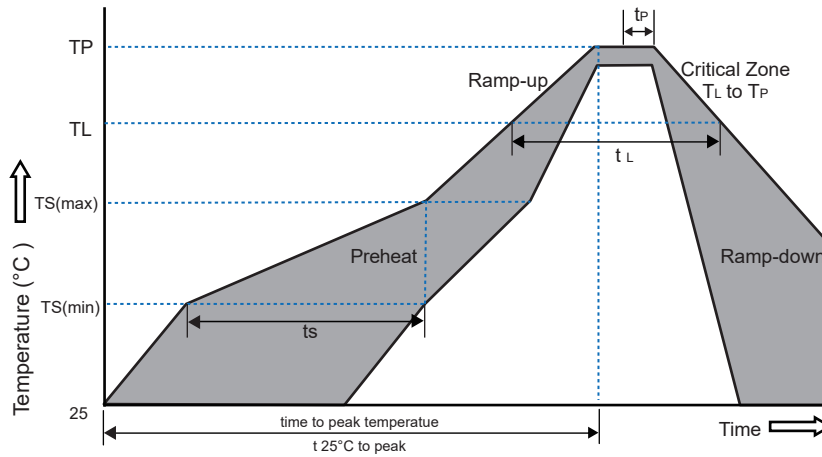

Reflow Condition		Pb-Free Assembly
Pre-heat	-Temperature Min($T_{s(min)}$)	+150°C
	-Temperature Max($T_{s(max)}$)	+200°C
	-Time(Min to Max)(t_s)	60~180 secs.
Average ramp up rate (Liquid us Temp(T_L) to peak)		3°C/sec. Max
Ts(max) to T_L - Ramp-up Rate		3°C/sec. Max
Reflow	-Temperature(T_L)(Liquid us)	+217°C
	-Temperature (t_L)	60~150 secs.
Peak Temp (T_P)		+260(+0/-5)°C
Time within 5°C of actual Peak Temp (t_p)		30 secs. Max
Ramp-down Rate		6°C/sec. Max
xTime 25°C to Peak Temp (TP)		8 min. Max
Do not exceed		+260°C

Part Number System

JE N1610 - 5V - U LC

